

Domain[®]

MP3/USB/BLUETOOTH PLAYER WITH
FM/MW TUNER



DM-CR1310BT INSTRUCTION MANUAL

SAFETY PRECAUTIONS

Thank you for purchasing this product. Please read through these operating instructions so you will know how to operate your model properly. After you have finished reading the instructions, keep this manual in a safe place for future reference.

Only connect the unit to a 12-volt power supply with negative grounding.

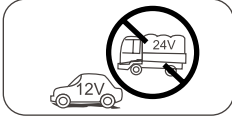

Never install this unit where the operation & condition for safety driving is restrained.



Never expose this unit, amplifier, and speakers to moisture or water for preventing electric sparks or fires.



Please don't change the fuse on the power cord without professional guidance, using improper fuse may cause damage to this unit or even cause fire.

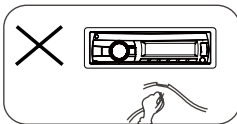

To ensure safe driving, please adjust the volume to a safe & comfort level in case of emergency situations.

Please power off this unit at once and send it back to the after-sales service center or the dealer/distributor you purchased from if one of the following symptoms is found:

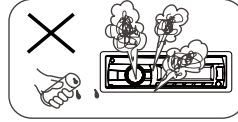

- (a). Water or other obstacle enters the unit;
- (b). Smoking;
- (c). Peculiar smell.

To provide a clear demonstration and an alternative for easy understanding of the operation of this unit, graphic illustration was used. However, this illustration is not necessary printed as the actual image found on the unit.

WMA and MP3 Compatibility

It is possible to playback WMA and MP3 files.

About WMA

The unit can playback WMA data. Windows Media and the Windows logo are trade marks or registered trademarks of Microsoft Corporation in the United States and/or other countries.

This unit may not operate correctly depending on the application used to encode WMA files.

About MP3

Supply of this product only conveys a license for private, non-commercial use and does not convey a license nor imply any right to use this product in any commercial (i.e. revenue-generating) realtime broadcasting (terrestrial, satellite, cable and/or any other media), broad-casting/streaming via internet, intranets and/or other networks or in other electronic content distribution systems, such as pay-audio or audio-on-demand applications. An independent license for such use is required. For details, please visit <http://www.mp3licensing.com>.

Safety Precautions	1
Features	2
Panel Controls.....	3
General Operation.....	4
Sound Setting.....	4
SWC	4
Tuner Operation	5
USB/MP3 PLAYBACK	5
MP3/WMA OPERATIONS	6
Bluetooth Functions.....	8
Menu Function.....	9
Anti-Theft System.....	9
Device Connections	10
Installation Guide.....	11
Troubleshooting.....	12
Specifications	13

PANEL CONTROLS

Power ON: Press [] button to turn on the unit.

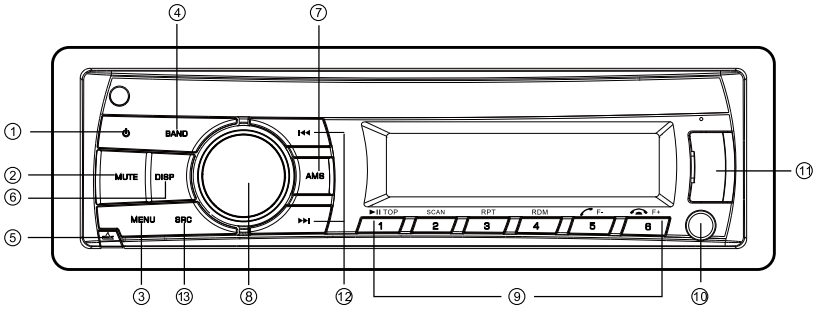

1. - Power
2. - Mute
3. - MENU:
 - USB mode: Search function
 - EQ menu setup (long press)
4. - Band switch (in Radio mode)
5. - Unlock the front panel.
6. - Display switch
 - System setup (long press)
7. - Preset scan
 - Auto memory store (long press)
8. - Adjust volume level / Confirm (press)
9. - Button 1: Play / Pause / Top play (long press) / Preset station 1
 - Button 2: Scan play / Preset station 2.
 - Button 3: Repeat play / Preset station 3.
 - Button 4: Random play / Preset station 4.
 - Button 5: Previous folder / Preset station 5. /MP3 track -10 down (long press)
 - BT mode: Answer / Dial / Call transfer
 - Button 6: Next folder / Preset station 6. /MP3 track +10 up (long press)
 - BT mode: Hang off / Reject a call / Disconnect the Bluetooth device (long press)
10. - Aux-in jack
11. - USB connector
12. - Previous / next track
 - Seek + / - (long press)
13. - Switch audio source

GENERAL OPERATION

Power On/Off Button

Press the [] button to turn the unit on when the vehicle ignition switch is on. Press and hold the button to turn the unit off.

Adjust Volume level

Rotate the knob to adjust volume level. Rotate it clockwise to increase and anticlockwise to decrease the volume.

Audio Mute

Press the [MUTE] button to mute the volume from the system. "MUTE" will appear on the display panel and the volume will be muted. Press the [MUTE] button again, or rotate the knob to return the volume level to the setting in use before the Mute function was activated.

Mode Button (SRC)

Press the [SRC] button to change Radio, A2DP, USB (when USB is connected), or AUX play.

Auxiliary Input

To access an auxiliary device:

1. Connect the portable audio player to the AUX interface on the front panel.
2. Press the [SRC] button to select Aux-In mode.

Press SRC again to cancel Aux-In mode and go to the next mode.



Display Selector (DISP)

Press the [DISP] button to display the clock time, the time will display at all times. Press the [DISP] button again to turn back previous mode.

SOUND SETTING

Press and hold the [MENU] button to enter sound effect setting mode. First press shows current EQ, then rotate the knob to changes BEAT EQ in this order:

OFF <-> POP <-> ROCK <-> CLASSIC <->
JAZZ <-> CUSTOM

Rotate the knob to changes CUSTOM, and press the knob, the press [] or [] button to select and rotate the knob to select a value.



60HZ: (-6)- (+6)

200HZ: (-6)- (+6)

700HZ: (-6)- (+6)

2.5KHZ: (-6)- (+6)

15KHZ: (-6)- (+6)

Press and hold the [MENU] button to enter sound effect setting mode, then press [] or [] button to select USER preset including: BALANCE -> FADER -> LOUD, rotate the knob to select a value.



BALANCE:LEFT 1-7->CENTRE->RIGHT 1-7

FADER:FRONT 1-7->CENTRE->REAR 1-7

LOUD: ON/OFF

SWC

SWC SET

- 1 Press and hold [DISP] button to enter system setup.
- 2 Press [] or [] button to select SWC SET (The SWC SET options include: MODE/ VOL UP/VOL DN/SEEK UP/SEEK DN)
- 3 When the option "MODE" flash press and hold the corresponding SWC button, the "SET OK" appears in the display, this SWC setting is finish.
- 4 The next option will continue flash, then press and hold the next corresponding SWC button to finish the setting.
5. Repeat the above operation until the all options set OK.

TUNER OPERATION

Band

During radio play, press the [BAND] button to choose between three FM, two MW bands.

Up Tuning

Press the seek up [▶▶] button to tune stations upward step-by-step. The current frequency will be shown in digital format on the display panel.

Press and hold the seek [▶▶] button to the next available station.

Down Tuning

Press the seek down [◀◀] button to tune stations downward step-by-step.

Press and hold the seek down [◀◀] button to the previous available station.

Auto Memory Store

Press the [AMS] button to automatically select six stations and store them in the current band. The new stations replace stations already stored in that band.

USB/MP3 PLAYBACK

1. Loading USB equipment

Open the rubber cap, insert the USB into the connector and the unit play the music in the USB storer automatically, and the LCD will show USB.

2. Take out USB equipment

Push the SRC button and switch to non USB mode, then take off the USB storer, close the rubber cap.

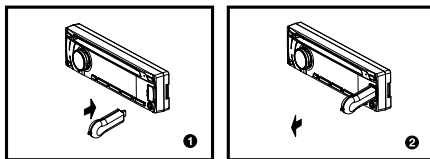

USB Notes

USB functions (flash memory type) MP3 music play

1. USB flash memory support.
2. Fat 12/fat 16/fat 32 is possible.
3. File name : 32 byte/dir name : 32 byte/tag name : 32 byte
4. Tag (ID3 tag ver 2.0)
- title/artist/album : 32 byte support.
5. USB 1.1 support, USB 2.0 support (It can not support USB 2.0 speed. Just, get the same speed with USB 1.1).



Note:

Not all USB devices are compatible with the unit.

MP3/WMA OPERATIONS

This unit can play back MP3/WMA files

Notes:

If you play a WMA file with active DRM (Digital Rights Management), no audio is output.

To disable DRM

(Digital Rights Management)

When using Windows Media Player 9/10/11, click on Tool -> Options -> Copy music tab, then under Copy settings, unclick the Check box for Copy protect music. Then, reconstruct files.

Personally constructed WMA files are used at your own responsibility.

Precautions when creating MP3/WMA file

Usable sampling rates and bit rates

1. MP3: Sampling rate 8 kHz-48 kHz, Bit rate 8 kbps-320 kbps / VBR
2. WMA: Bit rate 8 kbps-320 kbps

File extensions

1. Always add a file extension “.MP3”, “.WMA” to MP3, WMA file by using single byte letters. If you add a file extension other than specified or forget to add the file extension, the file cannot be played.
2. Files without MP3/WMA data will not play. The files will be played soundlessly if you attempt to play files without MP3/WMA data.
 - * When VBR files are played, the play time display may differ the play location.
 - * When MP3/WMA files are played, a little no sound part is caused between tunes.

Logical format (File system)

1. The folder name and file name can be displayed as the title during MP3/WMA play but the title must be within 32 single byte alphabetical letters and numerals (including an extension).
2. Do not affix a name to a file inside a folder having the same name.

Number of files or folders

1. Up to 999 files can be recognized per folder.
Up to 3000 files can be played.

2. Some noise may occur depending on the type of encoder software used while recording.

Pausing play

1. Press the [1/II TOP] button on the front panel to pause play.
“PAUSE” appears in the display.
2. Press the above button again to resume play.

Selecting a track

Track-up

1. Press the [►►] button to move to the beginning of the next track.
2. Each time you press the [►►] button, the track advances to the beginning of the next track.
3. For MP3/WMA tracks, press and hold the [6] button to move ahead to +10 tracks.

Track-down

1. Press the [◀◀] button to move back to the beginning of the current track.
2. Press the [◀◀] button twice to move back to the beginning of the previous track.
3. For MP3/WMA tracks, press and hold the [5] button to move ahead to -10 tracks.

Fast-forward/Fast-reverse

Fast-forward

Press and hold the [►►] button .

Fast-reverse

Press and hold the [◀◀] button .

Folder select

This function allows you to select a folder containing MP3/WMA files and start playing from the first track in the folder.

1. Press the [5] or [6] button.
Press the [5] button to move the previous folder. Press the [6] button to move the next folder.
2. To select a track, press the [◀◀] or [►►] button.

Search Function

Press the [MENU], then rotate the knob to choose FOLD SCH or TRK SCH.

Direct Song/File Access

MP3/WMA OPERATIONS

1. Press the knob to enter the track list search mode.
2. Turn the knob to select a digit.
3. Press the knob to confirm entry and the tens digit will flash.
4. Turn the knob to select digit.
5. Repeat above steps to enter the hundreds and thousands digit, if necessary.
NOTE: The unit will only allow the selection of digits that correspond with the number of files on the media you are searching.
6. Once the track number appears on the screen, press the knob to play the selected song/file.

Searching Folders/Files

1. Press the knob to enter the folder list search mode.
 2. Turn the knob to select a file or folder, press the [MENU] button to turn back the previous folder.
 3. Press the knob to enter the search mode. And then the list appears in the display.
 4. Turn the knob to select a track or folder.
 5. If there is a track, press the knob to play. If there is a folder, press the knob to go on searching.
- * When play back MP3 / WMA file, this function is performed in the current folder.

Top function

The top function resets the player to the first track. Press and hold the [1] button to play the first track (track No. 1).

- * In case of MP3/WMA, the first track of the current folder will be played.

Other various play functions

Scan play

This function allows you to locate and play the first 10 seconds of all the tracks.

Press the [2] button to perform scan play.

Repeat play

During playback, press [3] button, "TRK RPT" repeated play the current track; Press [3] again, "FOLD RPT" repeated play the current fold;

Press [3] button repeatedly until "RPT OFF" appears on the LCD to cancel repeat playback.

Random play

This function allows you to play the current track random play being played in the MP3/WMA folder.

1. Press the [4] button "RDM ON" appears on the LCD to perform random play.
2. Press the [4] button repeatedly until "RDM OFF" appears on the LCD to cancel random playback.

Bluetooth Functions

Pairing

Use this function to establish a connection between the unit and your mobile phone.

1. Turn on the unit.
2. Turn on Bluetooth function of your mobile phone, keep phone within 3 meters to the unit and start to search for Bluetooth devices.
3. After the name of the Bluetooth module "DOMAIN" appears on the pairing list of your mobile phone, select it. At this time, a pairing code is required. Enter the pairing code "0000", and the Bluetooth pairing will process automatically.

After pairing successfully, BT icons will light up.

BT mode selecting

Press [SRC] button to choose A2DP mode.

Receive

1. After pair successfully, if there is a call incoming, the unit switch to BT mode automatically.
2. Press [5] button to receive.
3. Press [6] button to hang up.

Call Transfer

During talking, press [5] button to transfer audio from the unit to your mobile phone.

Note:

Some mobile phones will transfer audio from the unit to themselves once the incoming call is answered.

Music Mode

A2DP

A2DP is short for Advanced Audio Distribution Profile. The mobile phones supporting this function can transmit stereo audio, whereas the ones not supporting this function can transmit mono audio only.

On A2DP music playing mode, press [1] button to choose pause/play mode.

Press [▶▶] button to previous or next track.

MENU FUNCTION

At all mode, press and hold **[DISP]** button to enter system setup. Press **[◀◀]** or **[▶▶]** button to select options, rotate the knob to adjust.

CLOCK

Press the knob to enter clock setting mode, rotate the knob to set clock, press **[◀◀]** or **[▶▶]** button to select hour or minute, press and hold the knob to confirm.

AUTO ANS (BT mode) ON/OFF

Rotate the knob to choose auto ans ON or OFF at BT mode.

AUTO CON (BT mode) ON/OFF

Rotate the knob to choose auto connect ON or OFF at BT mode.

DX/LO (RADIO mode)

Rotate the knob to choose radio local or distant at RADIO mode.

- **LO**: Only stations with strong signal can be received.
- **DX**: Stations with strong and weak signals can be received.

SCROLL ON/OFF

Rotate the knob to choose SCROLL ON or OFF.

For track information that is longer than the display panel:

When SCROLL is ON, the LCD will display ID3 TAG information cyclely, e.g: TRACK->FOLDER->FILE->ALBUM->TITLE->ARTIST->TRACK->...

When SCROLL is OFF, the LCD will display one of the ID3 TAG information, the default is TRACK, but user can adjust it to other ID3 TAG information by press **[DISP]** button.

12/24H

Rotate the knob to choose time format: 12 or 24 hour.

ANTI-THEFT SYSTEM

This unit is equipped with a detachable panel. Removing this panel makes the radio totally inoperable.

Remove the detachable panel

1. Press  button.
2. Hold the part popped out and pull the panel out.
3. Gently press the button of the case and open the cover. Place the panel into the case and take it with you when you leave the car.

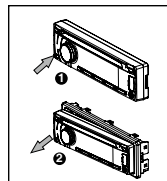

Install detachable panel

1. Fix right part of face plate in the panel slot of the unit.
2. Press down the left side of the face plate until it clicks into the panel slot.

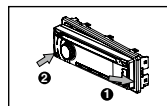

Remove the unit

1. Switch off the power of the unit.
2. Remove the panel and the trim plate.
3. Insert both Removal Keys into the hole on the front of the set until they lock.
4. Pull out the unit.

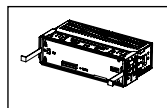

DEVICE CONNECTIONS

Wiring Diagram

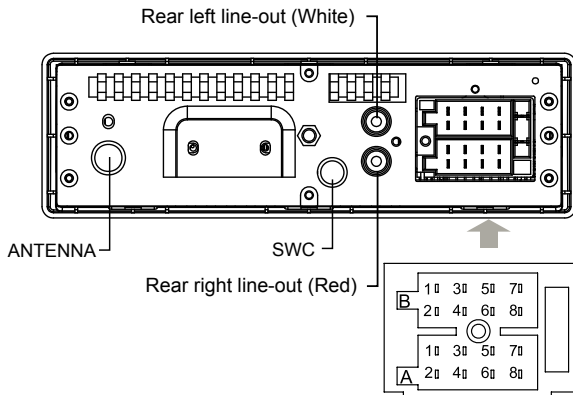

A Compartment		B Compartment	
No.	Pin Definition	No.	Pin Definition
A1	NC	B1	Rear Right(+)
A2	NC	B2	Rear Right(-)
A3	NC	B3	Front Right(+)
A4	Battery +	B4	Front Right(-)
A5	AMP/ANT Remote	B5	Front Left(+)
A6	ILL	B6	Front Left(-)
A7	ACC+	B7	Rear Left(+)
A8	Ground	B8	Rear Left(-)

INSTALLATION GUIDE

Installation Opening

This unit can be installed in any dashboard having an opening as shown below. The dashboard should be 4.75mm - 5.56mm thick in order to be able to support the unit.

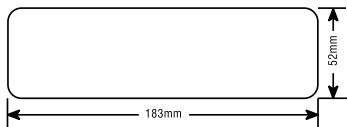

If the opening is too small, carefully cut or file as necessary until the sleeve easily slides into the opening. Do not force the sleeve into the opening or cause it to bend or bow. Check for sufficient space behind the dashboard for the unit chassis.

Reset

Press the RESET button with a pointed object to reset the unit to the original status.

Note: Press the RESET button will erase the clock setting and stored stations.

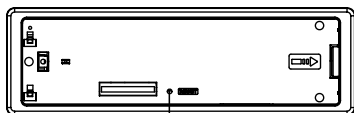

Reset

Installation Procedures

1. If relevant, remove any other audio system from the car.
2. Insert the mounting sleeve into the dashboard. Fix it firmly in place by folding down the metal tabs.
3. Perform the required electrical connections.
4. Then check that everything works before installing the main unit.
5. Remove the two screws on the top of the unit, otherwise, the unit will not work.
6. Install the car radio in the dashboard using the supplied screws (M5x6mm).
7. Attach the outer trim frame.
If you are not sure how to install this unit correctly, contact a qualified technician.

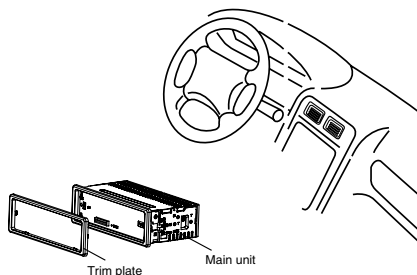

TROUBLESHOOTING

If you suspect something is wrong, immediately switch power off. Immediately stop using it and call the store where you purchased it. Never try to repair the unit yourself because it is dangerous to do so.

Problem	Possible cause	Solution
General		
The unit will not switch on.	Car ignition is not on. Cable is not properly connected. Fuse is burnt.	Turn your car key in the ignition. Check cable connection. Replace fuse with a new fuse of the same capacity.
No sound	Volume is set at minimum or the mute function is on.	Check the volume or switch the mute function off.
The unit or screen does not function normally.	The unit system is unstable.	Press the RESET button.
TUNER mode		
Unable to receive stations.	The antenna is not connected properly.	Connect the antenna properly.
Poor quality reception of radio station.	The antenna is not fully extended or it is broken.	Fully extend the antenna and if broken, replace it with a new one.
Preset stations are lost.	The battery cable is not properly connected.	Connect the permanent live on the unit to the permanent live on the vehicle.
USB mode		
Unable to insert USB device.	The USB device has been inserted the wrong way round.	Insert it the other way around.
The USB device cannot be read.	NTFS format is not supported.	Check that the USB file system is in FAT or FAT32 format. Due to different formats, some models of USB storage devices or MP3 players may not be read.

SPECIFICATIONS

General

Power supply:	12VDC (11V-16V), Test voltage 14.4V, negative ground
Maximum power output:	45W x 4 channels
Continuous power output:	20W x 4 channels (4 Ω 10% T.H.D.)
Suitable speaker impedance:	4-8ohm
Pre-Amp output voltage:	2.0V (Play mode: 1KHz, 0dB, 10K Ω load)
Fuse:	15A
Dimensions (WxHxD):	188 x 58 x 98mm
Weight:	0.52kg
Aux-in level:	\geq 300mV

FM Stereo Radio

Frequency range:	87.5-108.0MHz
Usable sensitivity:	8dB μ
Frequency response:	30Hz-15KHz
Stereo separation:	30dB(1KHz)
Image response ratio:	50dB
IF response ratio:	70dB
Signal/noise ratio:	>55dB

AM(MW) Radio

Frequency range	522-1629KHz
Usable sensitivity (S/N=20dB)	30dB μ



Note:

Specifications and the design are subject to change without notice due to improvements.

